

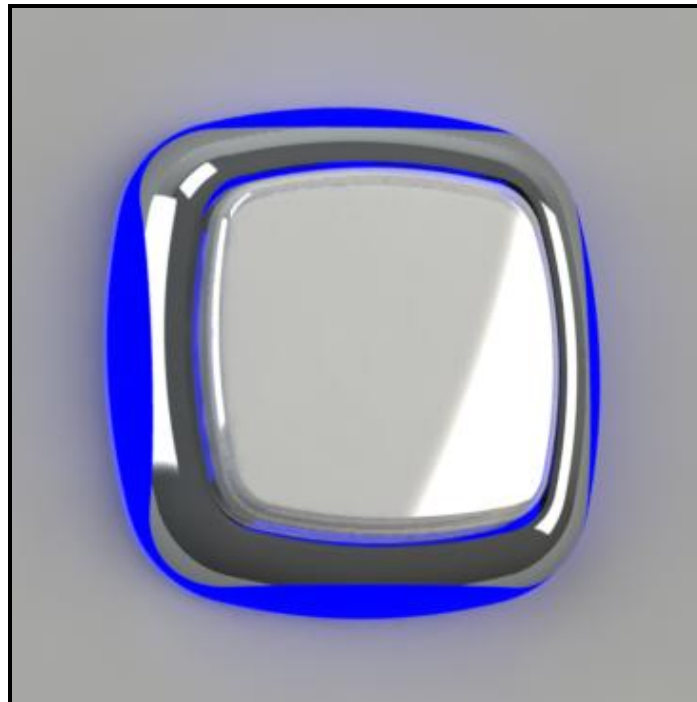

Gamesman

GPB1250 Push Button Product Specification

Issue 06: Date 10.02.2025



Disclaimer:

The information provided within this product specification is intended only to make the reader aware of the product's technical data and its use thereof. As such, Gamesman Ltd shall not be held liable for any loss or damage to the assembly or component within, arising from its misuse or from the unintended use of information or particulars included within, or any omission from, this document.

Design and specifications are subject to change without notice.

Failure to observe the interface requirements specified in this document may result in damage to the electronics and resultant performance characteristics of the product.

DRAWING No.
GDD03800

THIS DRAWING AND ANY INFORMATION SET OUT HEREON IN ARE THE CONFIDENTIAL PROPERTY OF GAMESMAN AND MUST NOT BE DISCLOSED, LOANED, COPIED OR USED FOR ANY OTHER PURPOSE WITHOUT WRITTEN PERMISSION.

DESIGN COPYRIGHT RESERVED.
DO NOT SCALE.
THIRD ANGLE PROJECTION.
DIMS TO APPLY AFTER PLATING.

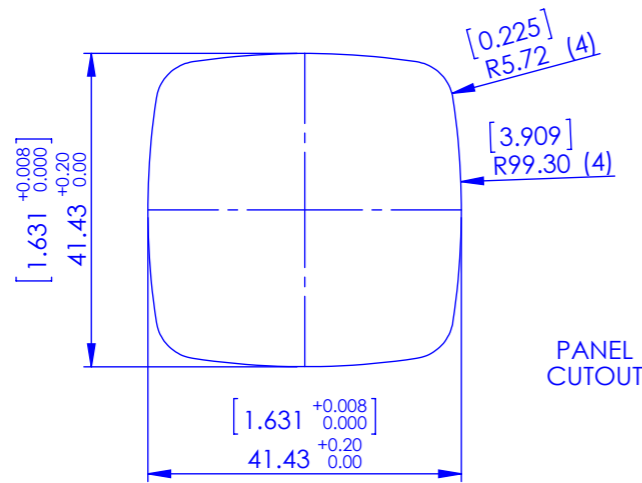
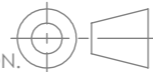

PANEL THICKNESS:
MIN: 1.40 [0.055]
MAX: 2.00 [0.079]

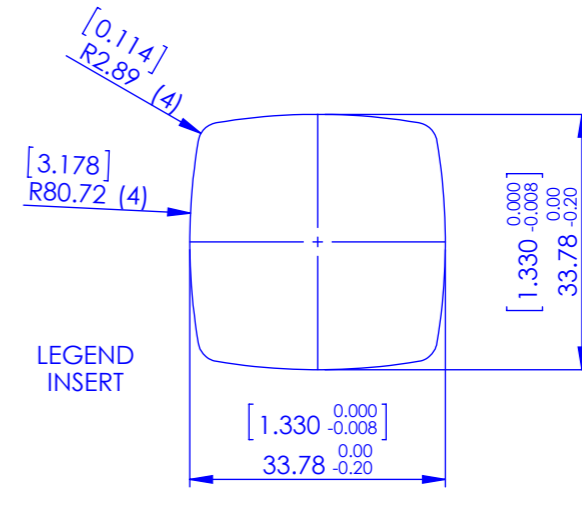
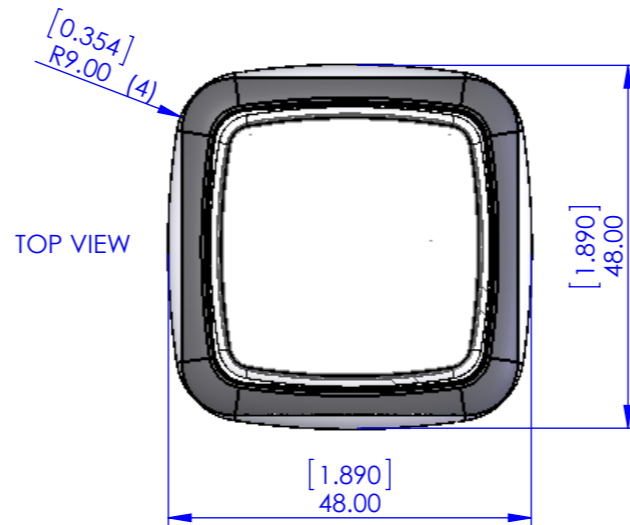

INSERT THICKNESS:
MAX: 0.30 [0.012]

BUTTONS VIEWED FROM TOP

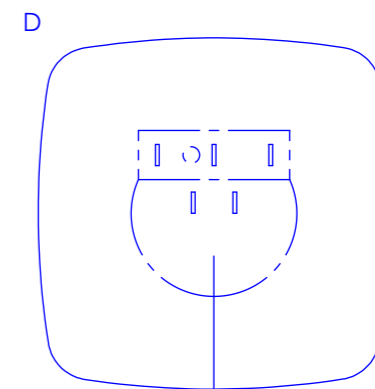
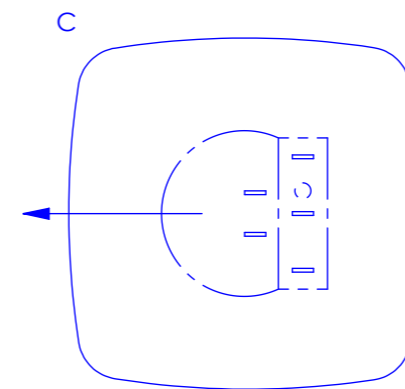
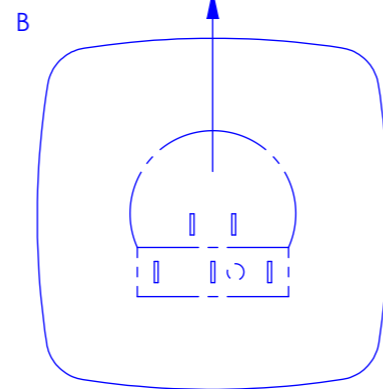
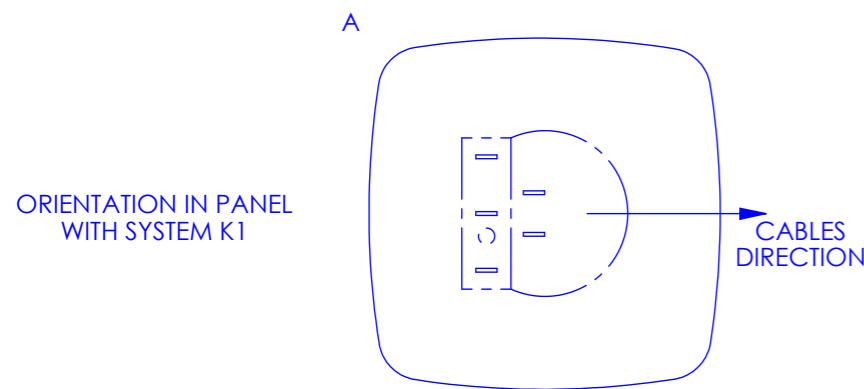

ORIENTATION OF TEXT ON INSERT

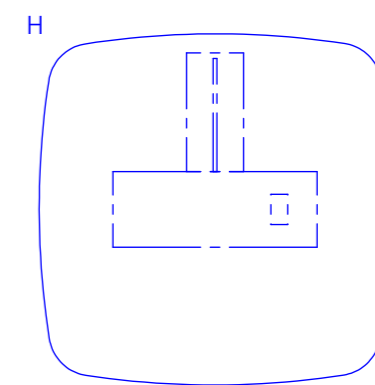
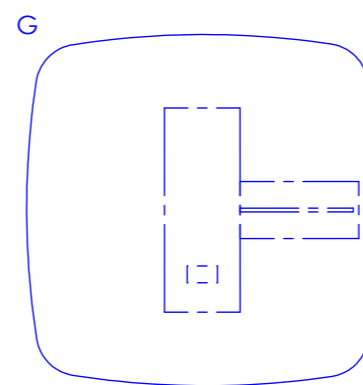
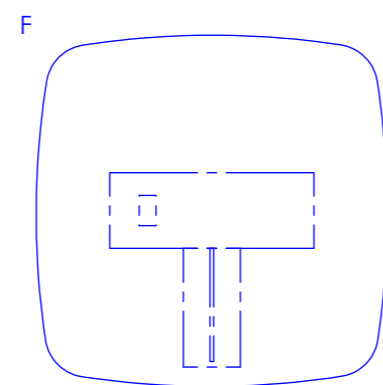
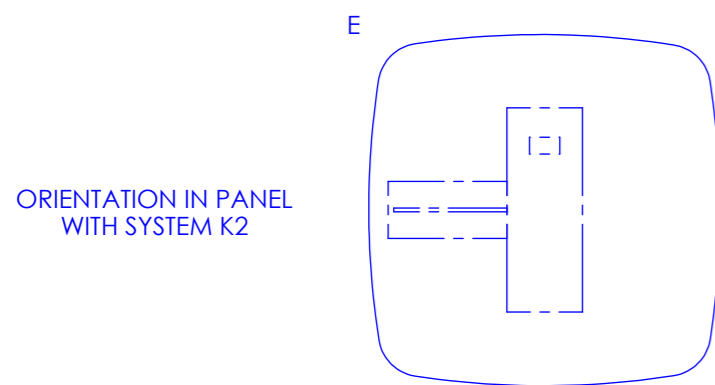

APPROVED	<p>Unit 6, Crompton Fields, Crompton Way Crawley, West Sussex, RH10 9QB, UK Tel: +44(0)1293 418888 Fax: +44(0)1293 418880 http://www.gamesman.co.uk</p>	THIS PART MUST BE RoHS COMPLIANT	DIMS mm	SCALE 1:1	1	11/09/2014	NEW DRG	DRAFT ISSUE	V.PORTILLO
DRAWN V.PORTILLO		FINISH SEE PART DRAWING	TOLERANCES UNLESS OTHERWISE SPECIFIED: 0.00 DIMS ±0.13 0.0 DIMS ±0.40 ANG ±0.5°, DRAFT ±1° PER SIDE CONCENTRICITY ±0.08 MAX ○ - DENOTES INSPECTION DIMENSION	ISS.	DATE	ECN NUMBER	REVISION DETAILS	NAME	
DATE 11/09/2014		MATERIAL SEE PART DRAWING							TITLE GPB1250 SPECIFICATION

DRAWING No.
GDD02399

THIS DRAWING AND ANY INFORMATION SET OUT HEREON IN ARE THE CONFIDENTIAL PROPERTY OF GAMESMAN AND MUST NOT BE DISCLOSED, LOANED, COPIED OR USED FOR ANY OTHER PURPOSE WITHOUT WRITTEN PERMISSION.

DESIGN COPYRIGHT RESERVED.
DO NOT SCALE.
THIRD ANGLE PROJECTION.
DIMS TO APPLY AFTER PLATING.

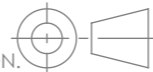

BOTTOM SHOT IN ANY TRANSLUCENT COLOUR (OR OPAQUE IF HALO IS NOT DESIRED)

STANDARD HALO

TOP SHOT IN ANY COLOUR (CHROMING AVAILABLE)

CONTROLLABLE RGB HALO

BOTTOM SHOT IN:
-CLEAR, FOR A HOT-SPOT STYLE HALO
-OPAL, FOR A DIFFUSED HALO

BEZEL AND LENS HEIGHT DIMENSION COMMON ON ALL 1200 BUTTONS

[0.378]
9.60

[0.236]
6.00

[1.120]
28.5

SYSTEM K1

[1.766]
44.9

SYSTEM K2

HALO BOARD AND SLEEVE SCREWED BEHIND THE PANEL AFTER BUTTON IS CLIPPED INTO THE PLATE

FOR STANDARD HALO, GAMESMAN RECOMMENDS 5 LEDS CENTRAL ILLUMINATION

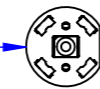

FOR CONTROLLABLE RGB HALO CONFIGURATION, GAMESMAN RECOMMENDS 1 LED CENTRAL ILLUMINATION



ALL CONNECTION SYSTEMS FIT IN THE SAME BUTTON AND CAN BE USED WITH ANY BUTTON CONFIGURATION

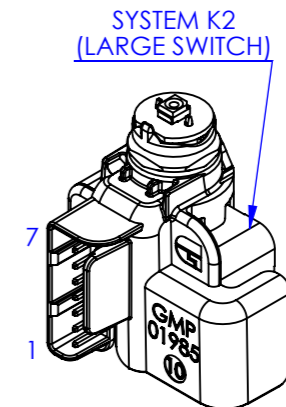
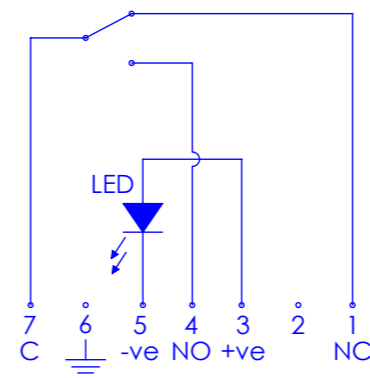
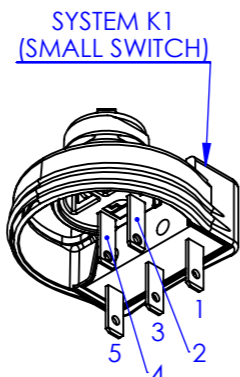
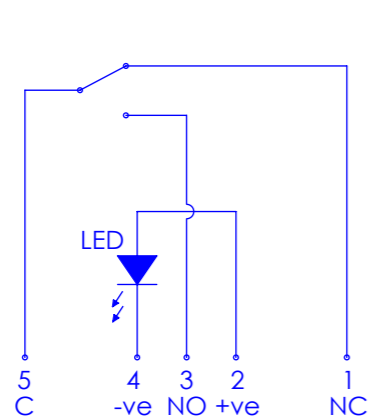

THIS DRAWING SHOULD NOT BE TAKEN AS REFERENCE FOR PART NUMBERS - SEE ASSOCIATED BUTTON SPEC SHEET

APPROVED	<p>Unit 6, Crompton Fields, Crompton Way Crawley, West Sussex, RH10 9QB, UK Tel: +44(0)1293 418888 Fax: +44(0)1293 418880 http://www.gamesman.co.uk</p>	THIS PART MUST BE RoHS COMPLIANT	DIMS mm	SCALE 1:1	4	16/07/2024	ECN-2687	ADD SHEET 2 WITH K3 AND K7 VIEWS	R.LOFFLER
DRAWN V.PORTILLO			FINISH SEE PART DRAWINGS	TOLERANCES UNLESS OTHERWISE SPECIFIED: 0.00 DIMS ±0.13 0.0 DIMS ±0.40 ANG ±0.5°, DRAFT ±1° PER SIDE CONCENTRICITY ±0.08 MAX ○ DENOTES INSPECTION DIMENSION	ISS. 3	08/10/2012	ECN-1394	K3 SYSTEM ADDED	V.PORTILLO
DATE 15/05/2012			MATERIAL SEE PART DRAWINGS	TITLE 1200 SERIES SPECIFICATION	REVISION DETAILS		SIZE A3	SHEET 1 of 2	DRAWING No. GDD02399

DRAWING No.
GDD02399

THIS DRAWING AND ANY INFORMATION SET OUT HEREON IN ARE THE CONFIDENTIAL PROPERTY OF GAMESMAN AND MUST NOT BE DISCLOSED, LOANED, COPIED OR USED FOR ANY OTHER PURPOSE WITHOUT WRITTEN PERMISSION.

DESIGN COPYRIGHT RESERVED.
DO NOT SCALE.
THIRD ANGLE PROJECTION.
DIMS TO APPLY AFTER PLATING.

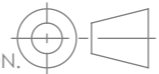

BOTTOM SHOT IN ANY TRANSLUCENT COLOUR (OR OPAQUE IF HALO IS NOT DESIRED)

STANDARD HALO

TOP SHOT IN ANY COLOUR (CHROMING AVAILABLE)

CONTROLLABLE RGB HALO

BOTTOM SHOT IN:
-CLEAR, FOR A HOT-SPOT STYLE HALO
-OPAL, FOR A DIFFUSED HALO

BEZEL AND LENS HEIGHT DIMENSION COMMON ON ALL 1200 BUTTONS

[0.378]
9.60

[0.236]
6.00

[1.766]
44.9

SYSTEM K3

[1.255]
31.9

SYSTEM K7

HALO BOARD AND SLEEVE SCREWED BEHIND THE PANEL AFTER BUTTON IS CLIPPED INTO THE PLATE

FOR STANDARD HALO, GAMESMAN RECOMMENDS 5 LEDS CENTRAL ILLUMINATION



FOR CONTROLLABLE RGB HALO CONFIGURATION, GAMESMAN RECOMMENDS 1 LED CENTRAL ILLUMINATION



ALL CONNECTION SYSTEMS FIT IN THE SAME BUTTON AND CAN BE USED WITH ANY BUTTON CONFIGURATION

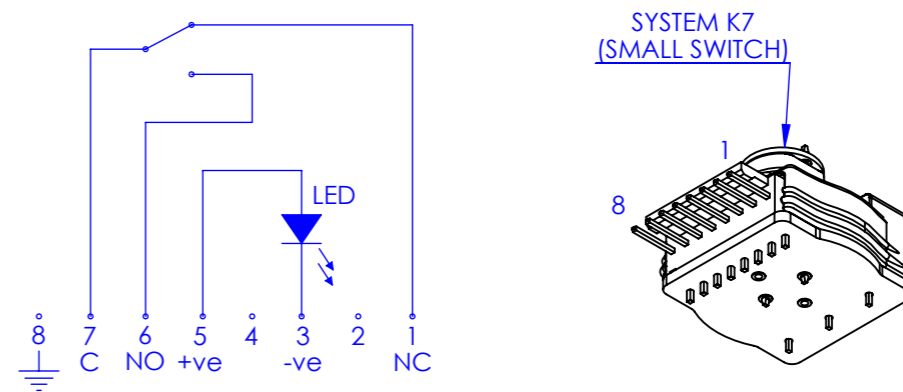
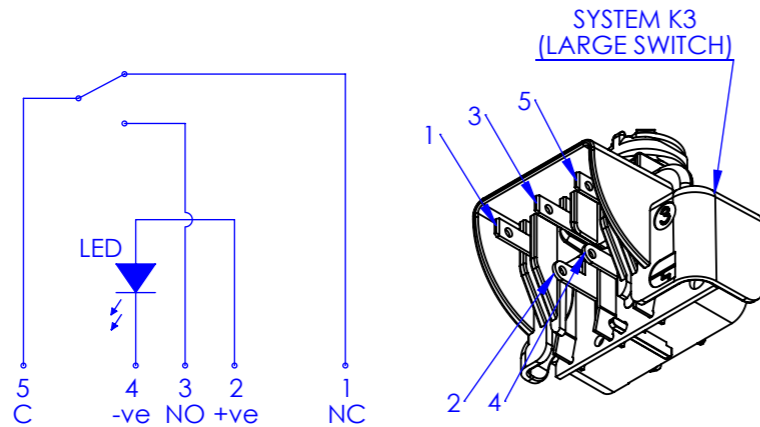

THIS DRAWING SHOULD NOT BE TAKEN AS REFERENCE FOR PART NUMBERS - SEE ASSOCIATED BUTTON SPEC SHEET

APPROVED	<p>Unit 6, Crompton Fields, Crompton Way Crawley, West Sussex, RH10 9QB, UK Tel: +44(0)1293 418888 Fax: +44(0)1293 418880 http://www.gamesman.co.uk</p>	THIS PART MUST BE RoHS COMPLIANT	DIMS mm	SCALE 1:1	4 16/07/2024 ECN-2687 ADD SHEET 2 WITH K3 AND K7 VIEWS	R.LOFFLER	
DRAWN V.PORTILLO			FINISH SEE PART DRAWINGS	TOLERANCES UNLESS OTHERWISE SPECIFIED: 0.00 DIMS ±0.13 0.0 DIMS ±0.40 ANG ±0.5°, DRAFT ±1° PER SIDE CONCENTRICITY ±0.08 MAX ○ DENOTES INSPECTION DIMENSION	3 08/10/2012 ECN-1394 K3 SYSTEM ADDED	V.PORTILLO	
DATE 15/05/2012			MATERIAL SEE PART DRAWINGS		TITLE 1200 SERIES SPECIFICATION	NAME	
					SIZE A3	SHEET 2 of 2	DRAWING No. GDD02399



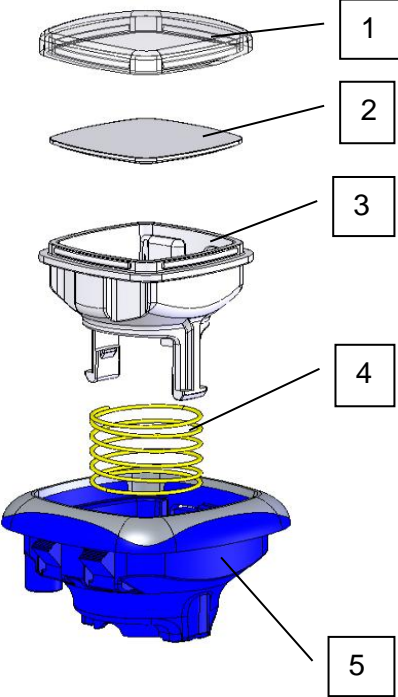



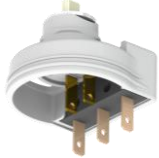

Product Identification

	No.	Part Number	Description	Material	UL94 Rating
	1	GMP03324	Lens	PC	UL94-V2
	2	GMP03323	Legend Plate	PC	UL94-V2
	3	GMP03322	Plunger	POM	HB
	4	G4-950	Spring	Carbon Steel	N/A
	5	GMP03321	Bezel	PC and ABS	HB and UL94-V2

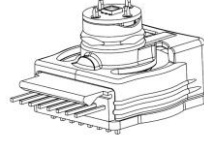
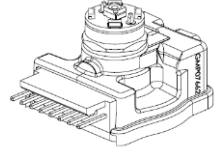
Note:

Item 5 is a “two shot” moulding, and therefore available in various colour combinations – see the button specification sheet for potential options. *Minimum order quantities may apply*

Product Compatibility

System	K1	K2	K3	K7	K7i
Illustration					
Datasheet					
Switch	Cherry DB3 or Cherry DB5	Cherry Large Tactile (NO & NC options for RGB)	Cherry Large Tactile	Cherry DB3 or Cherry DB5	Cherry DB3
White LED Options	12V or 5V, Single LED or 5 Radial LEDs	12V or 5V, Single LED or 5 Radial LEDs	12V or 5V, Single LED or 5 Radial LEDs	12V or 5V, Single LED or 5 Radial LEDs	12V 5 Radial LEDs Standard Height or Raised 3mm Height
RGB Option	No	Yes, Single RGB	No	Yes, Single & 3-RGB Options	No
Removable LEDs	No	Yes (Non-RGB LED Only)	Yes	No	No
Ingress Resistance	No	No	No	No	Yes

Order Codes for Separate LED Assemblies

System	K1	K2 & K3	K7
12V White Single LED	N/A	0927-G02207	N/A
12V White Radial 5-LED	N/A	0927-G01986	N/A
5V White Single LED	N/A	Please Enquire	N/A
5V White Radial 5-LED	N/A	0927-G03271	N/A
12V Red Radial 5-LED	N/A	0927-G04818	N/A
12V Blue Radial 5-LED	N/A	0927-G04776	N/A
12V Green Radial 5-LED	N/A	0927-G04816	N/A
12V White Single LED Reverse Polarity	N/A	0927-G02843	N/A
12V White Radial 5-LED Reverse Polarity	N/A	0927-G02844	N/A

Gamesman recommends Single Axial Central LED Option for Controllable Halo Versions & 5 Radial x LED Option (1 central and 4 side firing) for non-Controllable Halo Versions

For more details see the Gamesman Specification sheet for this button.
[GPB1250.xls](#), and details of various switch connection systems.

Accessories and Options

Halo Boards

Halo boards are separately powered LED PCBAs that are specifically mounted to the button of a button, for the purpose of illuminating the outer bezel. For multicolour RGB illumination, Gamesman recommends using Opal Bezels for this purpose. Additional Sleeves and screws are required to mount and illuminate the Halo Board correctly.

Part Number	Type / Colour
?	<p>RGB – Memory – Pre-Programmed – 5v (Option 1)</p> <p>This option consists of a memory chip located on the halo PCBA itself. This chip contains a pre-determined, pre-programmed LED sequence uploaded at the time of manufacture so that when voltage is applied, the PCBA automatically runs this sequence. As there is no independent 'control' of the LEDs this only has a 2pin connector – power and ground.</p>
?	<p>RGB – Without Memory – Controllable from External Source - 5v (Option 2)</p> <p>This option does not have the memory chip on board and as such will not automatically run a sequence when voltage is applied. However, it does have a 7way connector with pins that allow the customer to control the LEDs independently using their own LED controller board, via serial communication.</p>

Panel Mounting Options

The GPB1200 Series buttons feature Panel Mount clips that will secure the button to a metal panel up to 2mm thick (Including any additional coating or finish), with no additional hardware required. For customers who would like to use an additional Halo Board (See above), Gamesman can advise and supply sleeves and screws for a customer's cabinet.

Details of Securing the Sleeve, PCBA and Screw to Button

- 1) Insert Button into the panel from the front of the machine.
- 2) Lining up the fixing holes up in the Bezel, Sleeve and (optional) Halo PCB, use the screws provided to secure the Sleeve from the rear of the panel.
- 3) Lastly, snap the switch holder into the bezel.

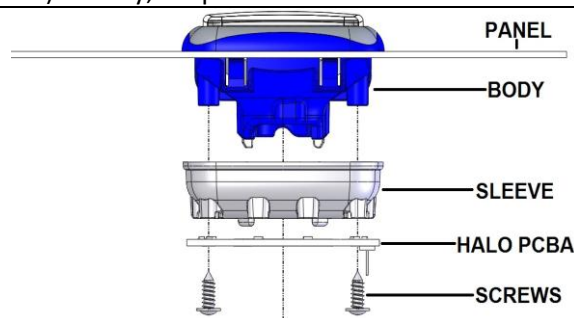



Sleeve and Screws Only

In addition to securing the Halo PCBA, the sleeve and screws can also be used by themselves to provide further security to thicker panels. Maximum allowances for this button per switch system is as follows:

K1	K2	K3	K7
2mm	8mm	6.5mm	2mm

Tools

<p>Extraction Tool for Pushbutton Order Part Number GMP03554</p>	<p>Insertion/Extraction Tool for K1, K2 and K3 Switch Order Part Number GMP02791</p>
	

Additional Ordering Details

Specification Sheet

Click the link below to complete a specification sheet of your requirements. If you have any questions regarding your options that are not covered in this document, please contact our Sales team.

[GPB1250.xlsx](#)

Packaging

Standard Packaging format for these buttons:

For Buttons **without a Halo Board, Sleeves or Screws:**

Lens & Legend Packed Separately in Bulk
Switch Connection System Assembled to the Button
Button Assembly Packed in Trays

For Buttons **with a Halo Board, Sleeve or Screws:**

Lens & Legend Packed Separately in Bulk
Switch Connection System to be loosely fitted into button
Button/Switch Assembly Packed in Trays
All Halo parts packed in bulk as kit of parts PER BOX (Sleeve, Screws & LED PCBA)

For any deviations from this please refer to specification sheet.

Space Models

3D CAD models link here, for other combinations please contact our Sales team.



Gamesman

GAMESMAN LTD
CROMPTON FIELDS, CROMPTON WAY, CRAWLEY, WEST SUSSEX, RH10 9QB
TEL: +44 (0) 1293 418888 FAX: +44 (0) 1293 418880

REGISTERED IN ENGLAND NO. 3027138

Website: www.gamesman.co.uk
E-mail: sales@gamesman.co.uk